



Thinking Skills Assessment Oxford

4502/11

Wednesday 30 October 2019

1 hour 30 minutes

SECTION 1

INSTRUCTIONS TO CANDIDATES

Please read this page carefully, but do not open the question paper until you are told that you may do so.

This paper is Section 1 of 2. Your supervisor will collect this question paper and answer sheet before giving out Section 2.

A separate answer sheet is provided for this section. Please check you have one. You also require a soft pencil and an eraser.

Please complete the answer sheet with your:

- TSA candidate number
- Centre number
- Date of birth
- Name

Speed as well as accuracy is important in this section. **Work quickly, or you may not finish the paper.** There are no penalties for incorrect responses, only marks for correct answers, so you should attempt **all** 50 questions. Each question is worth one mark.

Answer on the sheet provided. Questions ask you to show your choice between five options. Choose the one option you consider correct and record your choice on the separate answer sheet. If you make a mistake, erase thoroughly and try again.

You **must** complete the answer sheet within the time limit.

You can use the question paper for rough working or notes, but **no extra paper** is allowed.

Calculators are NOT permitted.



UNIVERSITY OF
OXFORD

Developed and administered on behalf of the University of Oxford by Cambridge Assessment Admissions Testing, a non-teaching department of the University of Cambridge.

Copyright © UCLES 2019

Please wait to be told you may begin before turning this page.

This paper consists of 38 printed pages and 2 blank pages.



BLANK PAGE

- 1 Like other booming cities, including New York, London has thrived amid globalisation. It is growing by 100 000 new residents a year. However, if London has given striving people plenty of reasons to come, it has done a poor job of housing them. The median price of a London home has tripled over the past two decades. Since 2001 the disposable income of people renting property has fallen by 30 per cent as a result. Businesses are worried too. Commercial property in central London is twice as expensive as in New York. Productivity has begun to slow as promising firms are forced out. Overpriced property is costing London the economic and human diversity on which its prosperity depends.

Which one of the following best expresses the main conclusion of the above argument?

- A London needs striving people in order to prosper.
 - B Londoners in rented homes have 30 per cent less to spend.
 - C London has done a poor job of housing its new residents.
 - D Businesses are worried by the recent slowdown in productivity.
 - E Expensive property is costing London the diversity it needs to prosper.
- 2 Each region in the country of Bolandia sets its own tax rate which applies to the whole of an individual's annual income.

Below is a table showing tax information relating to six different people.

<i>name</i>	<i>region</i>	<i>annual income</i>	<i>tax rate</i>
Tim	North	\$10 000	30%
Neil	Central	\$20 000	25%
Veronica	West	\$150 000	3%
David	North West	\$50 000	6%
Amy	East	\$80 000	5%
Roz	Frontier	\$12 000	30%

Who pays the same amount of tax in a year as Tim?

- A Neil
- B Veronica
- C David
- D Amy
- E Roz

- 3** A high degree of self-discipline is one quality exhibited by all athletes who have reached the uppermost levels of competition, whatever the sport. This amount of self-discipline is in evidence long after the initial excitement of a sport has worn off, and an athlete has had to keep going through years of painful and repetitive training sessions. The example of top athletes suggests one approach to improving student behaviour and educational achievement. If more young people could begin training programmes akin to those of elite athletes, they too would develop exceptional levels of personal discipline to apply within their studies.

Which one of the following best expresses the flaw in the above argument?

- A** High levels of self-discipline may not be all that it takes to become an elite athlete.
 - B** Young people may be able to develop self-discipline through other kinds of activities.
 - C** The kind of coaching support available to elite athletes may not be accessible to the general population.
 - D** Good behaviour and educational achievement during one's school years may not be essential for going on to lead a successful life.
 - E** Strong self-discipline may not be an effect of the training but rather a capacity already possessed by athletes as they start their training.
- 4** Young people are becoming ever more responsible. They are less likely to take drugs or drink than past generations. Very few have serious problems with alcohol or drugs. It is people in their forties who are most likely to be admitted to hospital for drinking-related problems. The latest figures on drug addiction show that 39% of heroin addicts are now over the age of forty, up from 19% in 2006. Fewer than ever are under the age of twenty-four. The number of young adults in prison is falling, but our overcrowded prisons are increasingly home to the older generation: between 2002 and 2013, the number of middle-aged men locked up increased by 130%. The same is true of suicide rates: on both sides of the Atlantic fewer young people but more middle-aged men are killing themselves.

Which one of the following can be drawn as a conclusion from the above passage?

- A** Young people have far fewer health problems than older generations.
- B** Some social problems are increasingly problems of middle-aged people.
- C** People who drink are more likely to engage in criminal activity.
- D** Drink, drugs and suicide are the biggest killers of middle-aged people.
- E** Young people are likely to develop harmful behaviours later in life.

- 5** Adults thinking back on their experience of school almost always remember with most gratitude the teachers who taught them more than just a subject, and prepared them for life, not just for an exam. But the current generation of students may not have the same experiences to look back on in future years because the role of teachers has changed. The focus for both students and teachers is now mainly on exam results, and that is how their success or failure is measured. For teachers to share their lives with their students, offering them a model of adulthood to which to aspire, is therefore no longer considered desirable. So children today receive a less valuable education than their parents and grandparents did.

Which one of the following is an underlying assumption of the above argument?

- A** Education for life is of greater value than merely passing exams.
- B** Adults looking back on their childhood often remember only the good parts.
- C** Many young people have higher ambitions than becoming like their teachers.
- D** Exam results are the vital keys which open the door to education and a livelihood.
- E** Offering students a model of adulthood is a more satisfying role than helping them to pass exams.

- 6 Below is a greyscale image of the flag of Canada. The flag consists of two red strips on the left and the right, a white square in the middle, and a red maple leaf in the centre.

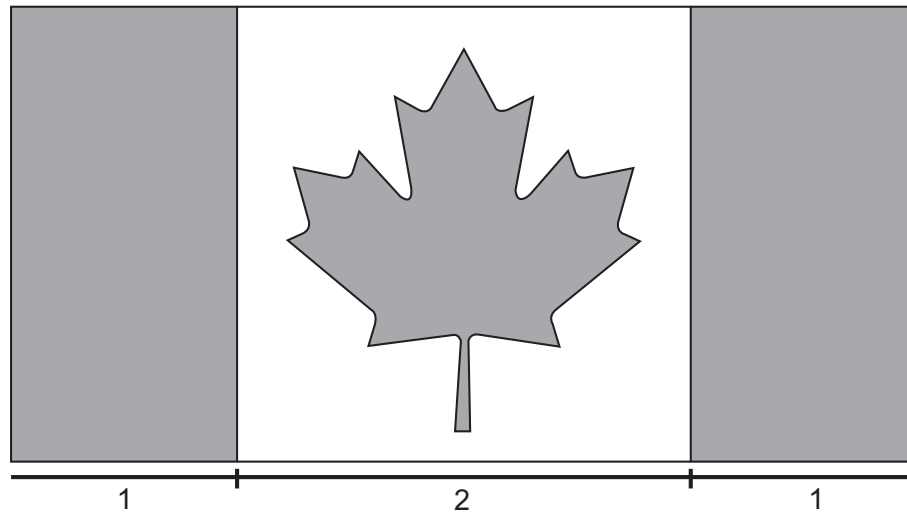

[diagram not to scale]

The width of the white square is twice as large as the width of a red strip. The red maple leaf occupies a quarter of the square in the middle.

What is the ratio of red to white in the flag?

- A 1:1
- B 2:1
- C 3:2
- D 5:3
- E 5:4

7 The table below shows the breakdown of marks awarded to students taking an exam.

<i>student</i>	<i>first examiner</i>	<i>first mark</i>	<i>second examiner</i>	<i>second mark</i>	<i>final mark</i>
Arnold Jones	Ms Rosenberg	80	Mr Robson	70	75
Betty Markham	Mr Kettering	90	Mrs De Vere	60	75
Clara Bird	Ms Nolan	60	Mr Robson	50	55
Cora Smith	Mr Kettering	80	Ms Rosenberg	80	80
Dave Howard	Mrs De Vere	90	Ms Rosenberg	90	90
Dennis Garton	Mr Kettering	80	Ms Nolan	70	75
Hillary Gordon	Mr Robson	50	Mrs De Vere	90	70
Janine Turner	Ms Rosenberg	80	Ms Nolan	90	85
Laurence Rothman	Ms Nolan	60	Mrs De Vere	50	55

The mark scheme is as follows: 90 = excellent; 80 = good; 70 = satisfactory; 60 = acceptable; 50 = fail. The final mark is the average between the marks given by the first and second examiners.

Which pair of examiners disagreed the most on the marks they awarded a student?

- A Mr Kettering and Mrs De Vere
- B Mr Robson and Ms Nolan
- C Ms Rosenberg and Ms Nolan
- D Mr Kettering and Ms Rosenberg
- E Mrs De Vere and Mr Robson

- 8 The bar chart shows the total numbers of tickets sold for a concert over three nights.

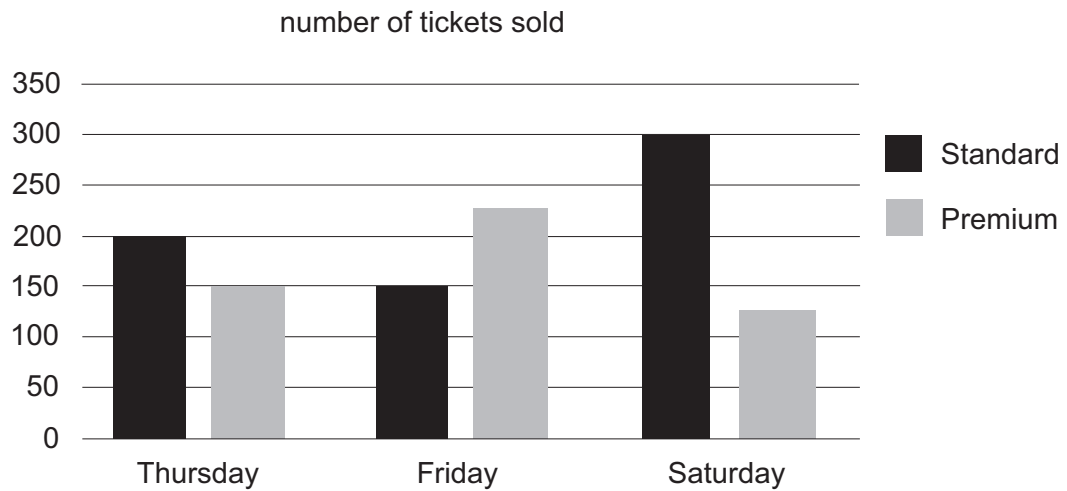

Premium tickets are more expensive than Standard tickets.

Which one of the following statements is correct?

- A The highest total sales income was for Thursday.
- B The highest total sales income was for Friday.
- C The highest total sales income could have been for Thursday or Friday.
- D The highest total sales income could have been for Thursday or Saturday.
- E The highest total sales income could have been for Friday or Saturday.

- 9** Texting is the preferred method of communication among young people, with 72% of teenagers saying they text regularly and one in three sending more than a hundred texts per day. Unfortunately, however, very few youngsters seem able to communicate using grammatically correct sentences. They seem to think it 'gr8' that correct spelling is no longer considered necessary. Many local employers have complained that school-leavers have no idea how to communicate appropriately, whether face-to-face or in business letters. Many written job applications are phrased so poorly that they go straight in the bin. Mobile phones were banned in my daughter's school last year, a move which has proved fully justified. Since then test scores in English have improved. All schools need to introduce a similar ban.

Which one of the following best expresses the flaw in the above argument?

- A** It makes a false statistical comparison between the 72% of teenagers who merely text regularly and those who send more than a hundred texts in a day.
 - B** It assumes that, because test scores improved after the ban on mobile phones, the improvement was due to the ban.
 - C** The argument rests on the assumption that communicating by text is inappropriate.
 - D** Its conclusion, that communicating by text is inappropriate, merely restates one of the reasons given in support of the argument.
 - E** It assumes that correct spelling is a necessary requirement for gaining employment.
- 10** While it is a woman, Ada Lovelace, who is often credited with originating the concept of software, today's computer tech-related jobs are held mostly by men. The tech sector must continue to work against factors that inhibit gender equality within it. One such factor appears to be prejudice about women's abilities to write computer programming code. A recent study of a program-sharing and development website analysed the rates by which suggested code changes were accepted by website users according to the gender of the user contributing the changes. In cases where the contributor's gender was not made clear on the website, 72 per cent of the suggestions made by women were accepted. In cases where the contributor's gender was revealed to be female, the acceptance rate fell to 63 per cent.

Which one of the following, if true, most weakens the above argument?

- A** Over the time period the website was studied, more female users than male users rejected suggested code changes overall.
- B** Leading firms in the tech sector have undertaken a variety of high-profile initiatives to encourage more women to pursue computer programming careers.
- C** No meaningful differences existed between the code changes suggested by female users who revealed their gender on the website and those who did not.
- D** Even by modern standards, Ada Lovelace received an extensive education in mathematics and the sciences.
- E** Male contributors to the website experienced a similar drop in their code change acceptance rates when their gender was revealed.

- 11 Schools have a duty to support the well-being of their students, and sport is one way to enhance this. Although many young people don't enjoy the competitive side of sport, there are many physical activities that don't require a competitive element, such as hillwalking and caving. Schools should offer these, or other non-competitive physical activities, as an alternative to traditional games lessons. Many people don't continue to play sport after they leave school, yet physical fitness is important in maintaining general health and the ability to work. Introducing alternative physical activities that are attractive for less competitive adults is therefore an important part of preparing students for life after school.

Which one of the following best expresses the main conclusion of the above argument?

- A Schools have a duty to prepare students for life after school.
 - B Many young people don't enjoy the competitive side of sport.
 - C Many people don't continue to play sport after they leave school.
 - D Schools should offer non-competitive alternatives to traditional games lessons.
 - E Young people should be encouraged to find a sport they enjoy.
- 12 When riding my bike in the dark, I use two rear bike lamps. Both of the lamps are in 'flashing mode', which means that they repeatedly emit light for a set period of time at set intervals. The reasons for using two lights are that it reduces the amount of time when neither of the lamps emit light, and that if one of the lamps stops working, other road users can still see me on the road. One of the lamps shines for one second and goes dark for one second repeatedly; the other lamp shines for two seconds and goes dark for two seconds repeatedly. I always turn both lamps on simultaneously at the start of my ride.

For how many seconds in each minute do **neither** of the lamps shine when they are in use?

- A 10
- B 12
- C 15
- D 20
- E 30

- 13 The following table compares five selected commuting routes in different European countries with respect to the length of the journey and the monthly cost of a season ticket as a percentage of average monthly wages.

comparison of selected commuting routes			
<i>journey</i>	<i>country</i>	<i>length (km)</i>	<i>cost as a percentage of average monthly wages</i>
Luton–London	UK	56	14
Brandenburg–Berlin	Germany	69	8
Karis–Helsinki	Finland	75	6
Uppsala–Stockholm	Sweden	72	6
Drogheda–Dublin	Ireland	46	5

On average, the commuters of which route spend the lowest proportion of their wages per kilometre of the route?

- A Luton–London
- B Brandenburg–Berlin
- C Karis–Helsinki
- D Uppsala–Stockholm
- E Drogheda–Dublin

14 Peter has drawn two diagrams showing information about the two cars owned by his parents:

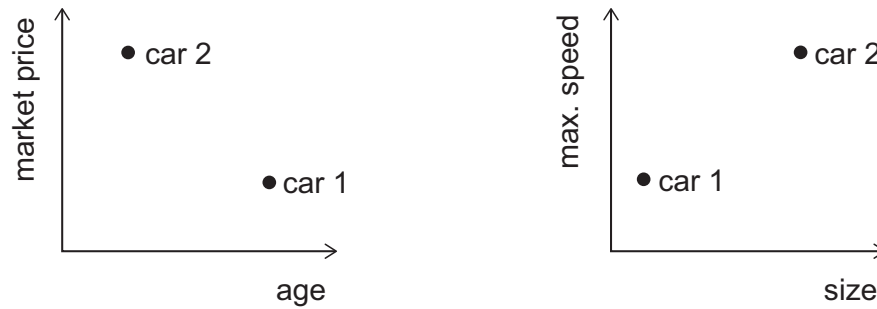

Which one of the following statements is **not** correct?

- A The more expensive car is newer.
 - B The cheaper car is bigger.
 - C The older car is slower.
 - D The newer car is bigger.
 - E The slower car is smaller.
- 15 Recently a pioneering natural flood management scheme slowed river peak flow by 15 to 20 per cent, saving a small town's museum and several homes. As part of this scheme, special dams, designed to leak water gradually, were installed in nearby hills to slow the flow of water off the slopes. An upstream flood storage reservoir was installed, along with the planting of thousands of trees and the restoration of heather moorland, which acted as a sponge. Around half of the reduction in flood water in the town was due to the upstream land management measures, and half due to the effect of the flood storage area. Natural flood management measures improve water quality, prevent erosion and, in some cases, store carbon.

Which one of the following can be drawn as a conclusion from the above passage?

- A The reduction in peak flow of a river would be insufficient to prevent flooding if there was very heavy rainfall.
- B The benefits of natural flood management schemes go beyond reducing flood risk.
- C All natural flood management methods are equally effective in reducing river flow.
- D Natural flood management should be introduced in all areas at risk of flooding.
- E Natural flood management methods are most effective in hilly upland areas.

- 16** The government is planning an increase in fuel tax later this year as part of its strategy to meet carbon emissions targets. Yet motorists and road transport companies have suffered crippling price rises of up to 30% in petrol and diesel bills in the past year because of fuel taxes. The government has enjoyed a £505 million windfall from high oil prices in the last six months alone, with extra revenue coming from North Sea oil reserves. A further increase in fuel tax will impact on all UK households because it will eventually push up the price of shop goods and inflation. So the government must abandon its planned tax increase.

Which one of the following is an underlying assumption of the above passage?

- A** The impact on people's pockets is more important than the need to control carbon emissions.
 - B** The cost of fuel is too high and must be reduced.
 - C** The only justification for higher fuel taxes is to reduce carbon emissions.
 - D** Road transport companies could go out of business if fuel tax is increased.
 - E** The government could use its increased levels of North Sea oil revenue to reduce fuel taxes.
- 17** Despite the recent decline in numbers of people getting married, it appears that there is still much to recommend it. Married people are happier, wealthier and live longer. Husbands and wives have a lower risk of disease and a higher life expectancy. They smoke less, drink less and eat more healthily. Those who get married and stay married have on average double the amount of wealth of those who never marry. Surveys show that they are happier than single people and less likely to experience mid-life depression. Married couples benefit from stronger networks of support, with relatives providing more care and assistance in old age and in times of need. Finding and committing to a marriage partner is a goal well worth pursuing.

Which one of the following, if true, most weakens the above reasoning?

- A** Research suggests that being married boosts the chances of surviving cancer.
- B** Statistics on marriage do not differentiate between those who have children and those who do not.
- C** In many countries, being married gives advantages in terms of tax payments.
- D** Individuals in conflict-ridden relationships are more prone to illness than happy couples.
- E** Wealthier couples are four times more likely to marry than poorer couples.

- 18** Three friends are training to run a marathon. Part of this training involves running steadily round a track in the local park. They are all at different stages in their training schedules so they run at different speeds. Alec completes each lap in 3 minutes, Barry takes 5 minutes and Colin takes 6 minutes.

They all leave the start line at the same time.

If they each maintain their running speed throughout the session, how many more laps will Alec have completed compared to Barry when the three of them next cross the start line together?

- A** 2
- B** 4
- C** 5
- D** 6
- E** 10

- 19 The table below shows the amount of waste recycled each year, in thousands of tonnes, over a three-year period in 20 countries.

<i>country</i>	<i>recycling year 1</i>	<i>recycling year 2</i>	<i>recycling year 3</i>
Ambrosia	52	64	65
Buranda	60	72	80
Carbonda	20	27	40
Elbonia	32	34	40
Friponia	36	39	45
Grandia	20	35	60
Hoollasia	50	56	60
Ishlapia	33	41	44
Jackaran	36	44	48
Killumpa	40	55	70
Lateralia	50	57	60
Moodle	80	98	90
Nalpha	32	44	48
Oritan	72	81	90
Phillim	66	69	70
Quaratus	80	90	100
Rutalia	75	76	90
Samalam	88	96	99
Tuddle	50	56	60
Ukliam	50	56	60

What is the biggest percentage increase in recycling in the table from year 1 to year 3?

- A 50%
- B 75%
- C 100%
- D 150%
- E 200%

- 20 The see-through glass block below can be viewed from six sides, including from above and below.

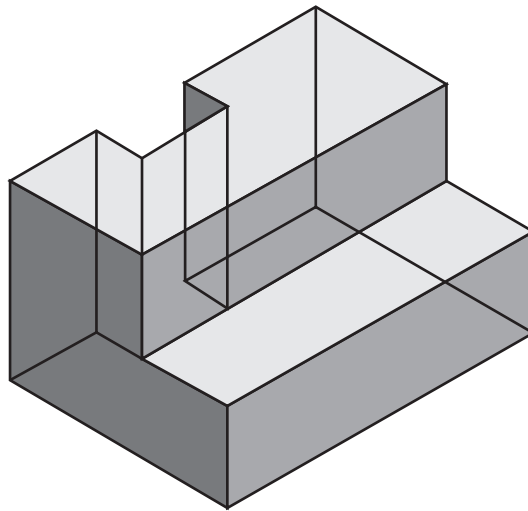

Which one of the following is **not** a possible view?

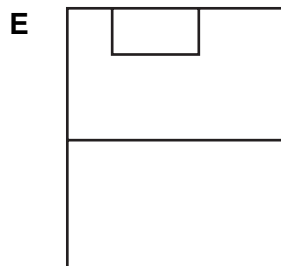
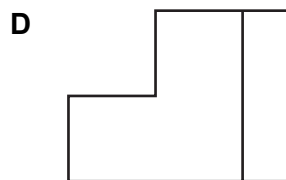
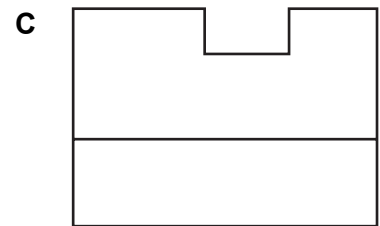
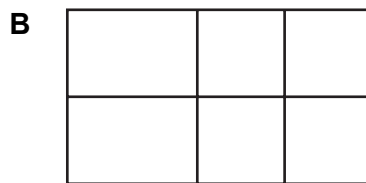
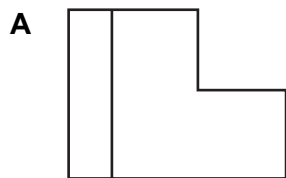

- 21** It is universally recognised that Africa's conservation tourism provides employment, generates wealth and educates future generations while saving endangered species. So we should champion tourism for the sake of conservation. Tourism in the Arctic is thus to be welcomed. As the Arctic ice melts, new shipping routes are opening up. It is unfair to characterise the presence of a large cruise ship in the Northwest Passage as 'extinction tourism' that merely indulges people who want to view endangered animals before it is too late. The tourists will return home better informed about the Arctic's fragile ecosystem.

Which one of the following best expresses the flaw in the above argument?

- A** It argues a general rule on the basis of one successful example of wildlife tourism.
 - B** It assumes that wildlife tourists only want to see endangered animals.
 - C** It assumes that wildlife tourism is more important than successful conservation.
 - D** It assumes that the cruise-ship tourists will see enough to return home committed to the conservation of the Arctic ecosystem.
 - E** The argument implies that conservation tourism will inevitably lead to the extinction of some species of animal.
- 22** If the vice president did act unlawfully in this matter, he would definitely have had to resign. Since we have confirmation that he has resigned, he must have broken the law.

Which one of the following most closely parallels the reasoning used in the above argument?

- A** If the snake that bit this woman was a king cobra, then she would be dead by now. As she is alive and well, the snake can't have been a king cobra.
- B** If the snake had yellow markings, then it was a pit viper. You say it did have yellow markings, so it must have been a pit viper.
- C** If what Mahmood saw was a diamondback rattlesnake, he would have been in real danger. Since there are no rattlesnakes where Mahmood was, he was actually quite safe.
- D** If a snake bite goes untreated for too long, there can be serious complications. Since I got prompt treatment, I didn't have any complications.
- E** If the snake that bit this victim was venomous, then the wound would be very inflamed. We can see that there is severe inflammation, so the snake must have been venomous.

- 23** It's common for people to agree in principle to socially useful projects such as the opening of centres for people with serious mental health problems. However, if the project is planned for the area where they live, they tend to object and suggest that alternative locations would be preferable. While they approve of the general idea of such projects, they won't tolerate any negative effects on their own lives. We really don't want to go back to outdated practices of housing people with mental health problems in remote areas with no contact with the general population. So we have to accept that these projects can only work if we live near, and interact with, the people they are designed to help. Practise what you preach!

Which one of the following illustrates the principle used in the above argument?

- A** People who think sport has been tainted by bribery and performance-enhancing drugs should not buy tickets to sporting events.
 - B** People who think more money should be spent on the health service should not complain when their income tax is increased to fund it.
 - C** Parents who think too much 'screen time' is bad for young children should not buy them so many electronic gadgets.
 - D** People who choose to be vegetarians should seek to persuade others not to eat meat or fish.
 - E** People who have benefitted from grants or bursaries for university education should lobby for others to have the same advantages.
- 24** A digital display consists of seven segments which light up in different combinations to produce digits. For example, to display the digit '1' the two right-hand segments light up as shown:



The display is used to show, in sequence, each of the digits 1 to 9.

What is the maximum and minimum number of times that any one segment lights up during this sequence?

	<i>maximum</i>	<i>minimum</i>
A	7	4
B	7	5
C	8	3
D	8	5
E	9	4

- 25** Sandi is planning a trip to the old city of Pordson. She wants to stay for four nights in order to visit all of the attractions, and one of the nights must be the Saturday so that she can attend a special music concert.

The table below shows the prices per night and details of the deals for the five main hotels in Pordson.

<i>Hotel</i>	<i>Mon</i>	<i>Tues</i>	<i>Weds</i>	<i>Thurs</i>	<i>Fri</i>	<i>Sat</i>	<i>Sun</i>	<i>Deal</i>
Grand	€60	€70	€70	€70	€50	€60	€60	3F2
Majestic	€40	€90	€70	€70	€40	€90	€40	SFSHP
Palace	€60	€90	€90	€70	€50	€90	€80	50%
Palms	€60	€80	€80	€50	€40	€60	€50	4FP3
Plaza	€70	€90	€90	€60	€50	€70	€50	CBK

Deals: 3F2 Stay 2 nights and get the 3rd night free
 SFSHP Stay Friday and get the Saturday night half price.
 50% 50% discount on all stays of 3 or more nights.
 4FP3 Stay 4 nights and get the cheapest night free.
 CBK €50 discount on stays of 3 or more nights.

What is the minimum that Sandi will need to spend on a hotel bill for her stay in Pordson?

- A** €110
- B** €120
- C** €140
- D** €145
- E** €160

- 26** A solid cube has 6 different shapes drawn on each of its 6 faces. A plan view showing all the shapes is given below. It is placed on the path drawn below with the triangular shape facing up. The cube is rolled, one face at a time, forward along the route shown, from start position until it reaches the end position.

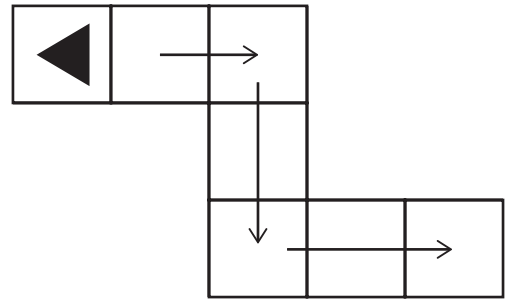
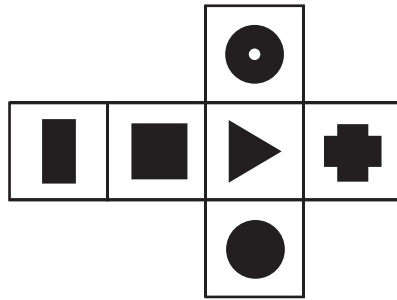
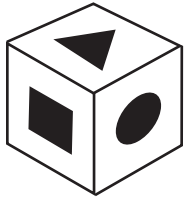

Which one of the following shapes is facing up when it reaches the end position?

A



B



C



D



E



- 27** People are quick to connect attempts to reduce the effects of climate change with the protection of the environment. However, responding to climate change is much more important for humanity than for nature. In the history of the planet, the relative stability of temperatures in the last ten thousand years is the exception rather than the norm. Nature has always found a way to adapt to large temperature variations but human civilisations, all of which have evolved in the last ten thousand years, have developed in a period with unusually reliable and predictable weather. Nature will find a way to move on, but climate change is potentially devastating for humans.

Which one of the following best expresses the main conclusion of the above argument?

- A** People are quick to connect climate change policies with environmental protection.
 - B** Acting against climate change is more important for humans than for the environment.
 - C** Nature has always found a way to adapt to large temperature variations.
 - D** Human civilisations have not yet been exposed to really large variations in temperature.
 - E** Nature will find a way to adapt, but climate change is potentially devastating for humans.
- 28** Chiropractors rely heavily on manipulating their patients' spines. This has benefits for some patients, but more than half of all patients suffer mild to moderate adverse effects after seeing a chiropractor. These are mostly local and referred pains that usually last for two to three days. Chiropractors often claim that these are necessary steps on the road to getting better. However, several hundred cases have been documented in which patients were seriously and often permanently damaged after chiropractic manipulations. What usually happens in these tragic instances is that, upon manipulation of the upper spine, an artery supplying the brain is overstretched and simply breaks up, leading to a stroke that can prove fatal.

Which one of the following is a conclusion that can be drawn from the above passage?

- A** Chiropractic therapy should be banned.
- B** Chiropractic therapy may do more harm than good.
- C** The spine is the most delicate part of the human body.
- D** People should see a doctor before going to a chiropractor.
- E** Pain is a necessary part of the healing process.

- 29** Drivers found to be committing offences such as speeding are now offered the choice between paying the police for a re-education course or taking the traditional penalty of paying a fine and receiving penalty points on their licence. It is no surprise that the number of motorists opting for re-education courses has tripled in five years, but the high cost of such courses has led to accusations that police forces might use the new system for their own benefit. They could easily set up speed traps, catch a number of motorists slightly over the limit, and generate easy income for themselves. Re-education courses are a good idea in theory, but open to abuse by cash-starved police forces.

Which one of the following is an underlying assumption of the above argument?

- A** The cost of running re-education courses is less than the combined contributions of participants.
- B** Re-education is more effective than punishment in preventing further motoring offences.
- C** Police forces are more interested in generating income than in preventing motoring offences.
- D** The number of driving offences committed in the last five years has tripled.
- E** Fear of losing a driving licence is greater than fear of financial hardship.

- 30** Alex and Sue are playing a game with a set of nine cards, numbered from 1 to 9. A 3×3 grid of cards is dealt onto the table. The cards for the next round have just been dealt and are as shown below.

5	1	8
3	6	2
9	7	4

The first player chooses two cards and scores the difference between the two numbers. The second player then chooses two cards from the seven that are left and scores the average of the two numbers. The highest score wins the round. Both players must choose cards that are either horizontally or vertically next to each other in the grid.

For this round of the game Alex has to decide whether to play first or second. She wants to make sure that she wins the round. If she has more than one possible winning move then she wants to achieve the highest score possible.

What should Alex choose to do?

- A** play first and choose the 1 and 8
- B** play first and choose the 3 and 9
- C** play first and choose the 6 and 7
- D** play first and choose the 7 and 9
- E** play second

- 31 The single ferry to Pepper Island starts each day from mainland Seatown and crosses to the island port of Kaysville. It runs back and forth from 9:30 am to 4:10 pm on Saturdays, Sundays and Bank Holidays, and from 10:30 am to 2:20 pm from Monday to Friday.

MAY						
M	T	W	T	F	S	S
1	2	3	4	5	6	7
8	9	10	11	12	13	14
15	16	17	18	19	20	21
22	23	24	25	26	27	28
29	30	31				

highlighted days = Bank Holidays

Each crossing takes 50 minutes. Between crossings, there is a 10-minute stopover for cleaning and refuelling. This is extended to 20 minutes on Saturdays, Sundays and Bank Holidays to allow for the increased cleaning requirements.

What is the maximum number of crossings the ferry can make in May?

- A 140
- B 144
- C 154
- D 166
- E 186

32 In March, 20 people voted for the position of chair of a committee. There were three potential candidates: Andrew, James and Roger.

In April, 11 of these people changed their votes, as follows:

- 3 people changed their vote from Andrew to James
- 2 people changed their vote from James to Roger
- 5 people changed their vote from Andrew to Roger
- 1 person changed their vote from Roger to James

Which one of these bar charts could **not** show the number of votes for the three candidates in March and April?

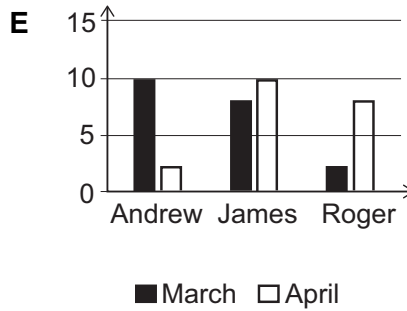
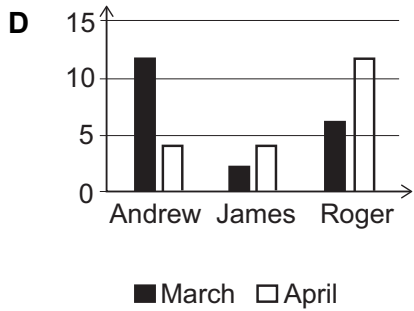
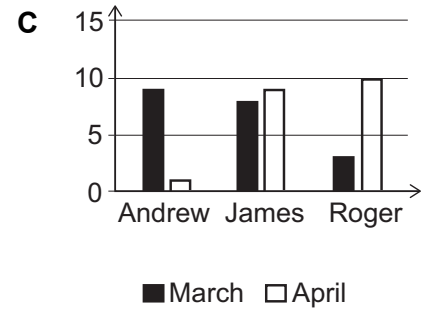
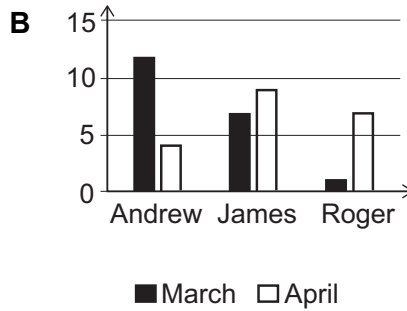
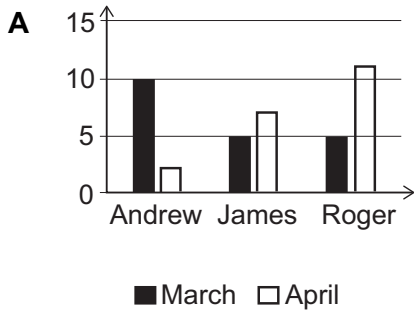

- 33** A band of rebellious traders in Wales has decided to take their whole town 'offshore' in protest at the insignificant amounts of UK tax paid by big businesses. An alliance of shopkeepers from the town want to use the same controversial loopholes favoured by huge multinationals such as Google so that they too can legally avoid UK tax. The coffee giant Starbucks, for example, has been branded immoral for transferring revenues out of the UK and into the Netherlands and Switzerland, where they receive sweetened tax deals. But the shopkeepers of the town cannot have it both ways. If they believe it is immoral for Starbucks to avoid UK tax, it is immoral for them, too. They should continue to pay UK tax in full.

Which one of the following, if true, most weakens the above argument?

- A** The sole purpose of the protest is to pressure the government into tackling tax avoidance by big business.
- B** If the shopkeepers are successful, every town could follow their lead, harming the UK economy even further.
- C** Small businesses acting alone cannot obtain the same tax breaks as the giant corporations.
- D** Every time the government comes up with a way of tackling tax avoidance, lawyers simply find a new loophole.
- E** One of the town traders found that last year he paid seven times more corporation tax than Facebook.

- 34** Much concern is paid to the hazards posed by people using mobile phones while operating motor vehicles. Although using a smartphone or other mobile phone behind the wheel of a car is most certainly dangerous, research is showing that very frequent usage of the phones is harmful more generally. A study has found that individuals with relatively high levels of mobile phone usage are more likely to demonstrate cognitive failures, which can range from forgetting appointments to accidentally bumping into things in the environment. Cognitive failures are associated with the short attention spans also observed in high-frequency mobile phone users. Clearly, if people want to reduce their risk of cognitive failures, they should limit the amount of time they spend on their mobile phones.

Which one of the following is the best statement of the flaw in the above argument?

- A** High-frequency mobile phone users may have had short attention spans prior to the formation of their phone usage habits.
- B** Limiting one's smartphone or mobile phone usage may not be a sufficient strategy for significantly reducing cognitive failures.
- C** Mobile phones may play an important role in the completion of everyday tasks in the lives of many people.
- D** Smartphones and other mobile phones may have different applications or features that are not all used in the exact same fashion.
- E** The risks posed by using a mobile phone while driving may be much greater than those posed by too-frequent usage of the phones overall.

- 35** Nearly everyone thinks it is a bad thing to be a hypocrite, because it is profoundly dishonest to pretend to have moral standards that you do not actually have. But pretending you are better than you are is evidence that you still accept the moral principles you have failed to follow. So it is better than being shameless about your moral failings. Perceived in this way, hypocrisy can be considered to be a virtue. Being a hypocrite shows you feel a need to hide some aspect of your life because it would be too embarrassing to allow it into the open. Many hypocrites wish they were the people they pretend to be: so perhaps one day they will succeed.

Which one of the following best expresses the main conclusion of the above argument?

- A** Hypocrisy is evidence of an inner need to conceal a shameful aspect of one's life.
- B** It is bad not to show any shame for the mistakes one makes in life.
- C** In some cases, hypocrisy may lead to moral improvement.
- D** It is possible to think of hypocrisy as a good thing.
- E** Hypocrisy is a serious moral weakness.

- 36 Nathan is making a pair of trousers for his young son. The diagram shows the pattern for one piece. Four such pieces are needed.

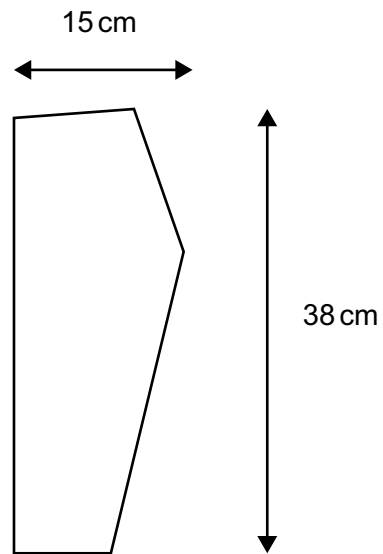

[diagram not to scale]

For simplicity he assumes that he will need a $15\text{ cm} \times 38\text{ cm}$ rectangle for each piece. The material comes in three widths with prices as shown:

<i>width</i>	<i>price / metre</i>
100 cm	£2.00
120 cm	£2.20
160 cm	£2.80

Material may be bought in lengths which are exact multiples of 10 cm.

What is the lowest price he can pay?

- A 42p
- B 56p
- C 60p
- D 66p
- E 80p

- 37 Arthur plans to modernise his bathroom. His design requires a 1600 mm × 700 mm bath. He wants side grips to help him get out of the bath, and because he doesn't want to choose the taps before ordering the bath he must have one which doesn't have pre-drilled tap holes.

A list from the bath catalogue is shown below:

<i>name</i>	<i>material</i>	<i>length</i>	<i>width</i>	<i>height</i>	<i>side-grips</i>	<i>pre-drilled tap holes</i>	<i>price (£)</i>
Balmoral	acrylic	1600	750	590	yes	no	159
Carola	acrylic	1600	700	610	yes	no	130
Dalton	steel	1600	700	580	no	no	112
Europa	steel	1600	700	590	yes	no	126
Gamma	steel	1600	700	580	yes	yes	135
Oporto	acrylic	1600	700	585	no	no	115
Polar	steel	1500	700	600	yes	no	120
Rocca	acrylic	1600	700	590	no	no	126
Sierra	steel	1600	700	580	yes	no	128
Victory	acrylic	1600	700	580	yes	no	149

How much will Arthur save by choosing the cheapest steel bath that fits his requirements rather than the cheapest acrylic bath that fits his requirements?

- A £2
- B £3
- C £4
- D £10
- E £18

- 38 The Head of Year 6 is planning an end-of-term treat for her students. The pie chart represents the numbers of votes cast by the children for each of the five possible outings.

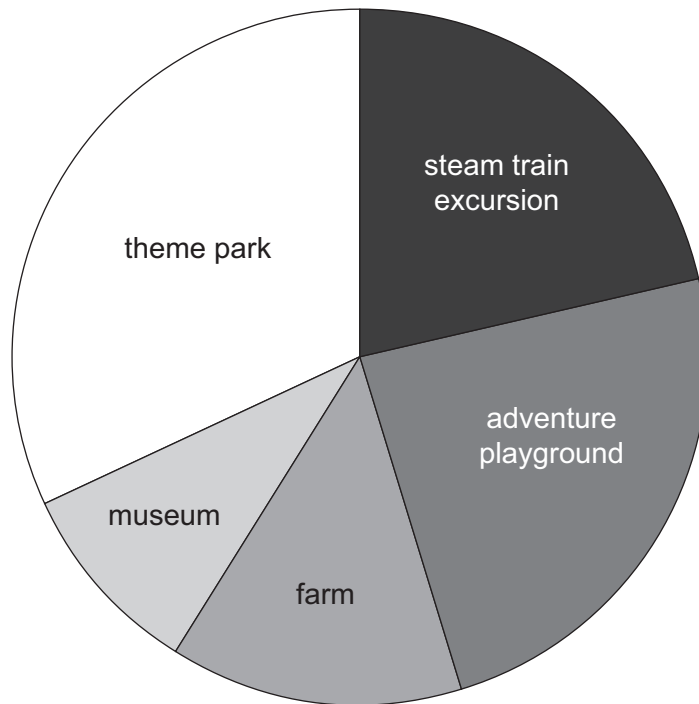

Which one of the following rows (**A–E**) could show the actual number of votes cast by the children for each of the options?

	<i>steam train excursion</i>	<i>adventure playground</i>	<i>farm</i>	<i>museum</i>	<i>theme park</i>	<i>total</i>
A	35	45	30	15	55	180
B	24	28	20	16	32	120
C	45	55	20	15	65	200
D	22	28	15	15	40	120
E	32	36	20	14	48	150

- 39** One of the greatest achievements of English grammar schools was the development and dissemination of a sophisticated system of standard punctuation for the English language. The complex rules for the use of commas conveyed a range of precise meanings, while the choice between semi-colon, colon and full stop expressed the exact, and often subtle, relationship between statements. Without this kind of attention to punctuation, there is bound to be a loss of precision in communication and in thinking. The current use of commas to join statements together, without any regard for grammar or the nature of the link between them, lacks rigour and covers up lazy thinking.

Which one of the following can be drawn as a conclusion from the above?

- A** Most writers do not want to waste time thinking through the exact connections between their ideas.
- B** Only a minority of people ever grasped the finer aspects of the traditional system of punctuation.
- C** Schools should go back to teaching the traditional system of punctuation.
- D** The government should reintroduce grammar schools into the UK.
- E** The vocabulary and grammar of a language naturally evolve over time, and the same is true of punctuation.

- 40** Long hours and poor pay have become commonly accepted, but they are taking a heavy toll on life at home. It is not a pretty picture: an economy where high levels of stress and anxiety are normal, where people get ill because they have lost control of their time, and where marriages are damaged and children suffer. Yet it is a situation that politicians invite us to applaud. They praise 'strivers' and 'hard-working people', not chilled-out, caring mums and dads. The longer and harder we work, the more admirable we are supposed to be. So the political slogans have clearly been effective, but the resulting glorification of work has made us miserable.

Which one of the following is an underlying assumption of the above argument?

- A** Most employees are not satisfied with their salary.
- B** Political slogans significantly affect people's everyday behaviour.
- C** Restructuring the working week would be beneficial for the economy.
- D** Companies could afford shorter hours or better pay for their employees.
- E** People who experience less stress at work are better parents.

- 41** Despite recent improvements to their training, a new study suggests that the police are as susceptible as the general public to holding false beliefs about crime and punishment. Participants in the study were questioned about their views on a number of crime-related myths such as ‘capital punishment is an effective way to deter criminal activity’ – myths, because they are unsupported by research evidence. Police were just as likely to endorse the misconceptions as the lay participants and, moreover, were more confident in their false beliefs. This is a worrying example of a ‘scientist–practitioner gap’, a term which describes a situation where professionals do not accept the evidence of research relevant to their roles. Studies have shown that training can permanently reduce the ‘scientist–practitioner gap’. Police officers need more training.

Which one of the following, if true, most strengthens the above argument?

- A** The recruitment process for new police officers often fails to identify false beliefs held by applicants.
- B** The majority of police officers do not support the return of capital punishment.
- C** The science–practitioner gap is a common phenomenon in many professions, not just the police.
- D** Police training has often been criticised in the media for being insufficiently practical.
- E** Police officers whose views are not evidence-based are more likely to have complaints made against them by members of the public.

42 The drawing below shows an allotment shed.

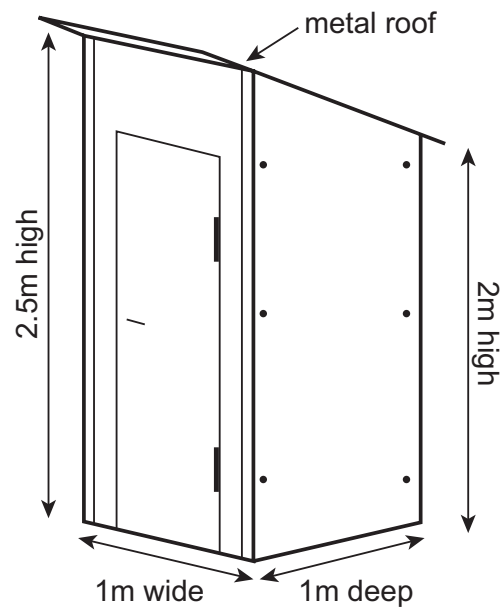

[diagram not to scale]

The four outside wood surfaces of the shed, including the door, need to be painted with three coats of paint. It takes 4 minutes to paint 1 square metre.

I have two identical sheds to paint and will take just one 20-minute tea break.

How long will it take to paint the two sheds?

- A 36 minutes
- B 1 hour and 48 minutes
- C 2 hours and 8 minutes
- D 3 hours and 36 minutes
- E 3 hours and 56 minutes

- 43 A school party consisting of 4 teachers and 20 students is visiting the theatre. Of the students, 8 are aged 15 years and 12 are aged 16 years. The following table shows the entry prices to the theatre.

<i>category</i>	<i>price</i>
Adult (16 years and over)	\$30
Child (5–15 years)	\$20
Under 5 years	free
Family ticket (2 adults and up to 2 children under 16 years)	\$90
Group ticket (8 people including at least 2 children under 16 years)	\$175
Supergroup ticket (any 8 people)	\$200

What is the least amount that the school party must pay for entry to the theatre?

- A \$525
- B \$530
- C \$545
- D \$550
- E \$560

44 Consider the following net, which forms a hexagonal prism:

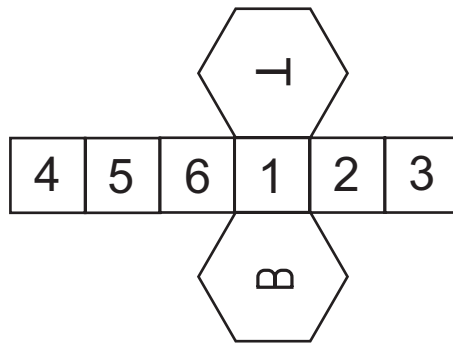

Which one of the following nets will form an identical prism?

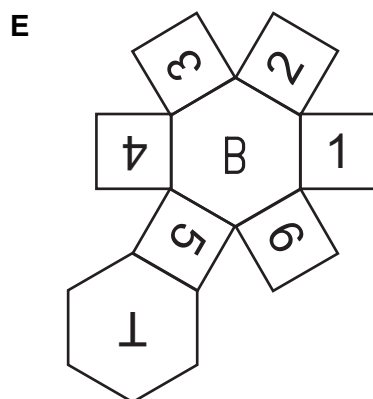
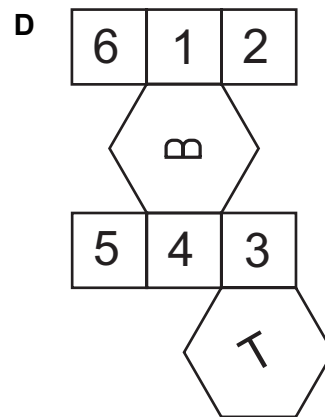
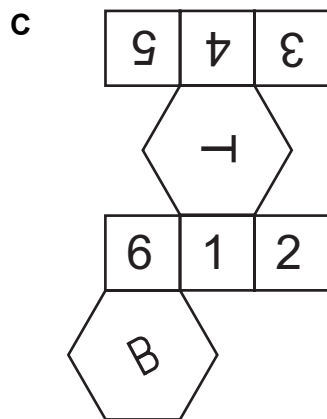
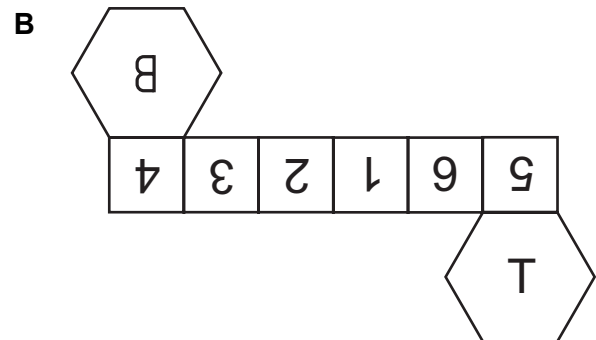
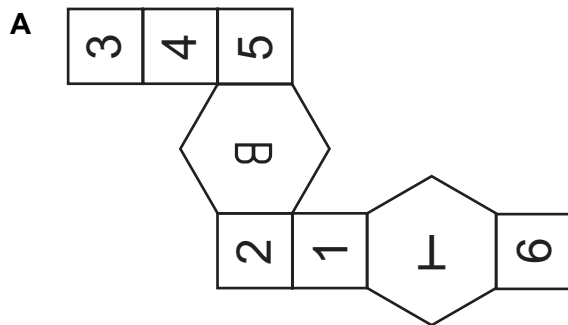

- 45** An accident at the Fukushima nuclear power plant in Japan in 2011 caused the release of radioactive material, resulting in around half a million people being evacuated from the area. These people have not been allowed to return to the area because of the health risks of exposure to radiation. But the psychological consequences of long-term evacuation may be more significant than the physical effects of radiation. People who wish to return to live in the area around Fukushima should be allowed to. Studies of a similar situation at Chernobyl showed that average life expectancy for evacuees reduced – not predominantly because of cancer caused by radiation, but because of depression, alcoholism and suicide due to the impact of permanent evacuation. There is, moreover, massive disagreement in the scientific community over how much radiation is ‘safe’.

Which one of the following best expresses the main conclusion of the above argument?

- A** The increased risks of cancer due to exposure to radiation have been exaggerated.
 - B** There is no consensus among scientists about what constitutes a safe level of radiation.
 - C** People who are forcibly evacuated from their homes experience reduced life expectancy.
 - D** People should be allowed to make their own decisions about living in the affected area.
 - E** The negative effects of radiation may be less significant than the psychological consequences of evacuation.
- 46** Your cake will be tasty only if you use fresh ingredients which you can only buy at the market. You did not go to the market, so your cake will not be tasty.

Which one of the following most closely parallels the reasoning used in the above argument?

- A** You can only be happy if you are healthy. To be healthy, you have to eat a lot of vegetables. You eat a lot of vegetables so you must be happy.
- B** She either went to school or to the playground. She is not in the playground, so she must have gone to school.
- C** If you light a candle, there is light and, if there is light, I am able to read to you. You must have lit a candle because I can read.
- D** Listening to loud music through earphones damages hearing. His hearing is fine which means that he must not have listened to loud music through earphones.
- E** Good knowledge of the car is necessary for fixing it. Without fixing the car, we will not arrive at the wedding in time. We will surely be late as we do not have good knowledge of the car.

- 47** Costs of health care in the UK are shared through taxation, but some of those who can afford to pay for a higher standard of care choose to do so. Some think it is immoral for rich people to receive better health care simply because they can afford to pay for it. But the whole point of money is to enable those who have it to improve the quality of life of themselves and their families. If money did not offer such advantages, it would not motivate people to develop their skills or to work harder in order to earn more. Since people are morally entitled to use their money to buy advantages for themselves and their loved ones, there can be no objection to private medicine.

Which one of the following illustrates the principle used in the above argument?

- A** People who have been born rich should not waste their inherited wealth in gambling, self-indulgence and extravagant living.
 - B** It is a good thing for people from rich countries to take foreign holidays, because the income generated by tourism benefits the local economy.
 - C** People who are born talented are under a moral obligation to develop their talents and to apply them energetically for the good of humanity.
 - D** Rich people should give away some of their wealth to benefit those less fortunate than themselves.
 - E** Inheritance tax should be set at a fairly low rate so that the children of rich parents inherit enough money to make a substantial difference to their lives.
- 48** Sourdough, an ingredient of many bread products, is a fermented mixture of flour and water. At 8:00 am on Monday morning, I start with a mixture of 50 g flour and 50 g water. Each morning at 8:00 am I double the weight of the sourdough by adding equal weights of flour and water. I know that 1 g of the water content evaporates every hour.

The bread recipe that I would like to use requires 500 g of sourdough. I also want at least 50 g of sourdough left over so that I can continue growing it for next week's bread.

On which day am I going to have the necessary amount of sourdough?

- A** Tuesday
- B** Wednesday
- C** Thursday
- D** Friday
- E** Saturday

- 49 A 250 g bag of mixed nuts lists the contents on the packet as follows:

<i>nut</i>	<i>content</i>
almonds	20-30%
brazil nuts	10-20%
hazelnuts	5-15%
peanuts	30-40%
pecans	10-20%

As they are my favourite, I eat all the almonds in the packet and then re-weigh it. I find that the almond content was the minimum it could have been whilst being consistent with the labelling.

What is the largest possible peanut content of the nuts remaining in the bag after I have eaten the almonds?

- A 40%
- B 48%
- C 50%
- D 57%
- E 60%

50 The net below can be folded to make a Roman numerical dice.

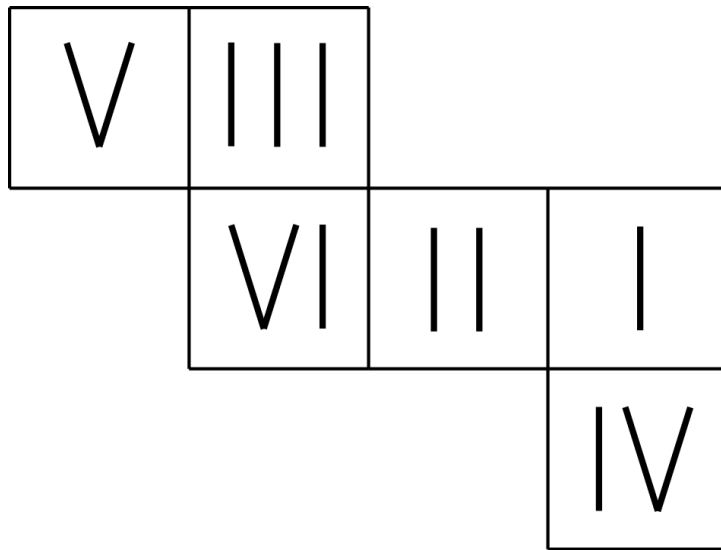

Which one of the following dice could have been made as a result of folding the net?

A

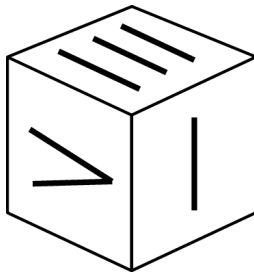

B

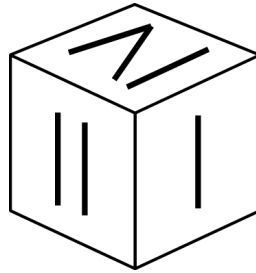

C

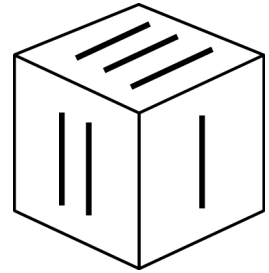

D

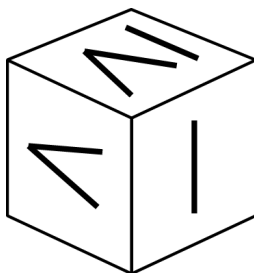

E

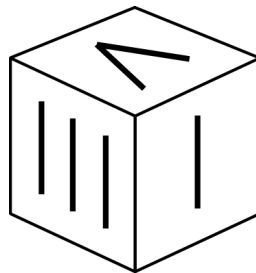

BLANK PAGE